

WARRANTY

Every Matrix® Elite HD back is carefully inspected and tested to provide optimum performance. Each back is guaranteed to be free from defects for a period of 24 months from the date of purchase, provided normal use. Should a defect in materials or workmanship occur within 24 months of the original date of purchase, Motion Concepts will, at its option, repair or replace it free of charge. This warranty does not apply to punctures, tears or burns, nor to the removable cushion cover.

The original back must be returned to the dealer and will become the property of Motion Concepts as a condition of processing the warranty claim. All warranty claims must be made through the dealer where the cushion was purchased. Except for express warranties made herein, all other warranties of fitness or use for a particular purpose are excluded. There are no warranties that extend beyond the warranties provided above. Remedies for breach of this warranty are limited to repair or replacement of goods. In no event shall damages for breach of any warranty include any consequential damages or exceed the original cost of the back.

matrix[™]
SEATING SERIES



Matrix[®] ELITE HEAVY-DUTY BACK



Invacare

www.invacare.com

USA

One Invacare Way
Elyria, Ohio USA
44036-2125
440-329-6000
800-333-6900

Canada

570 Matheson Blvd. E Unit 8
Mississauga Ontario
L4Z 4G4 Canada
800-668-5324

Motion Concepts

www.motionconcepts.com

USA

700 Ensminger Rd. Suite 112
Tonawanda, NY 14150
888-433-6818

Canada

84 Citation Dr.
Concord, Ontario L4K 3C1
905-695-0134



i IMPORTANT! The installation instructions contained in this manual should only be carried out by a qualified technician.

TRD0320-01

Table of Contents

- 1.0 General Warnings
- 2.0 Hardware Kit Contents
- 3.0 Tools Required
- 4.0 Before Installation - Important!
- 5.0 Matrix Elite HD Installation
- 6.0 Disengaging the Matrix Elite HD
- 7.0 Removing the Cover/Care Instructions
- 8.0 Lateral Supports (Optional)
- 9.0 One-Hand Cord Release Mechanism (Optional)
- 10.0 Lumbar Support (Optional)
- 11.0 Privacy Flap (Optional)

SAFETY SYMBOLS:

Proper set-up and safe use of your Matrix Elite HD Back depends on your own good judgement and common sense, as well as that of your provider, caregiver and/or health professional. The following symbols are used throughout this manual to identify warnings, cautions and important notes. It is very important that you read and understand them completely.

 **CAUTION!** Failure to heed the cautions in this manual may result in damage to your Matrix Seating product.

 **WARNING!** Failure to heed the warnings in this manual may result in personal injury.

 **IMPORTANT!** Important information to remember during installation and set-up of you Matrix Seating product.

 **IMPORTANT!** Please refer to the Wheelchair Owners/ Operators Manual for additional safety information, warnings and cautions related to the operation of your wheelchair.

1.0 General Warnings

WARNING!

DO NOT USE THIS PRODUCT OR ANY AVAILABLE OPTIONAL EQUIPMENT WITHOUT FIRST COMPLETELY READING AND UNDERSTANDING THESE INSTRUCTIONS AND ANY ADDITIONAL INSTRUCTIONAL MATERIAL SUCH AS OWNER'S MANUALS, SERVICE MANUALS OR INSTRUCTION SHEETS SUPPLIED WITH THIS PRODUCT OR OPTIONAL EQUIPMENT. IF YOU ARE UNABLE TO UNDERSTAND THE WARNINGS, CAUTIONS OR INSTRUCTIONS, CONTACT A HEALTHCARE PROFESSIONAL, DEALER OR TECHNICAL PERSONNEL BEFORE ATTEMPTING TO USE THIS EQUIPMENT - OTHERWISE, INJURY OR DAMAGE MAY OCCUR.

ACCESSORIES WARNING

Invacare products are specifically designed and manufactured for use in conjunction with Invacare accessories. Accessories designed by other manufacturers have not been tested by Invacare and are not recommended for use with Invacare products.

INSTALLATION WARNING

The procedures in this manual should be performed by a qualified technician. After any adjustments, repair or service and before use, make sure that all attaching component parts are secure.

DO NOT install the Invacare Matrx Elite assembly onto back canes with an outside diameter greater than 1-inch or less than 3/4-inch. Otherwise, injury or damage may occur.

The mounting position of the Invacare Matrx Elite is directly related to the chair's stability. When the Invacare Matrx Elite is added to a TILT and/or RECLINING chair, it may cause a decrease in the chair's stability. It may be necessary to reposition the FRONT CASTERS, REAR WHEELS, BACK ANGLE, TILT-IN-SPACE, RECLINE POSITION and/or SEAT DEPTH before use. Use extreme caution when using a new seating position.

When a Matrx Elite is added to a TILT and/or RECLINING chair, a RIGIDIZER BAR or CROSSBAR must be present to stabilize the back canes.

Ensure the Invacare Matrx Elite is properly secured to the wheelchair before using. Otherwise injury or damage may occur.

WARNING!

Skin condition should be checked very frequently after the installation of any new seating system.

Your therapist and physician should be consulted if you have any questions regarding individual limitations and needs.

Working with your therapist, physician, and equipment supplier is the best way to assure that a seating choice matches your individual needs.

As the needs of the individual become more complex, the seating evaluation becomes more important.

2.0 Hardware Kit Contents

- 2 - Heavy Duty Mounting Plates
- 2 - Cane Clamps
- 2 - Cane Inserts 7/8" (22mm)
- 2 - Cane Inserts 3/4" (19mm)
- 6 - Depth/Recline Adjustment Screws
- 6 - Cane Clamp Screws
- 2 - Set Screws
- 2 - Cane Clamp Nut Plates
- 4 - Long Mounting Pins (optional)

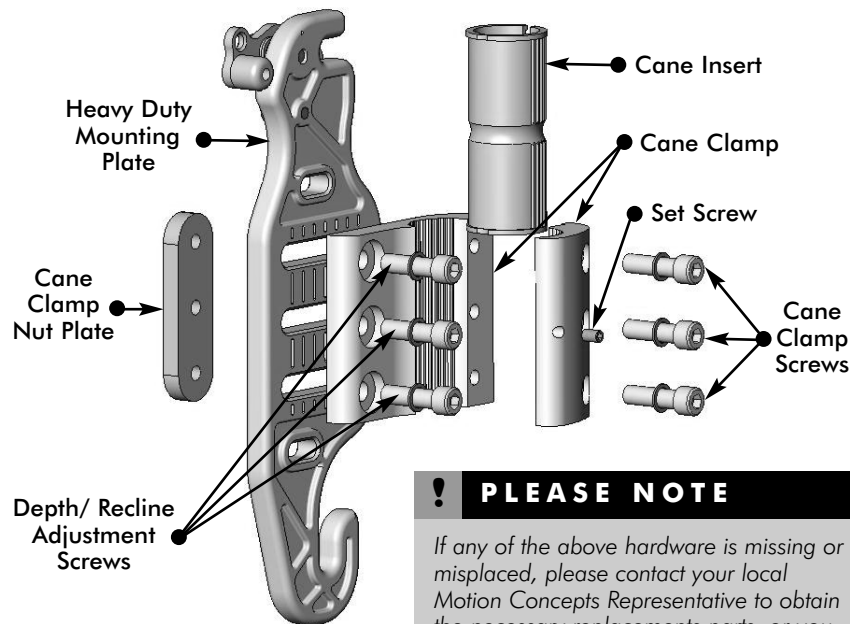

! PLEASE NOTE
 If any of the above hardware is missing or misplaced, please contact your local Motion Concepts Representative to obtain the necessary replacements parts, or you may contact our Customer Service Dept. directly for assistance.
 Canada: 905-695-0134
 USA: 716-447-005

3.0 Tools Required

- Wrench (22mm): (provided)
- Hex Key (5mm): (provided)
- Hex Key (2mm): (provided)

- Utility Knife/Scissors
- Tape Measure/Ruler

11.0 Privacy Flap (Optional)

Privacy Flaps (Optional):

Privacy flaps (1) are available (sold separately*) for use with our Elite series backs. Each Matrix Elite HD back comes with a pre-sewn loop strip across the bottom rear of the back cover (B) for installation of the privacy flap.



***Note:** to obtain sizing information and/or purchase a privacy flap, please contact our Customer Service Dept. for assistance.

Privacy Flap Installation:

1. If installed, remove the seat cushion.
2. Ensure the back is adjusted to the desired height. (Refer to section 5.0 Matrix Elite HD Installation).
3. Position the wheelchair in front of you so the back is facing you.
4. Align the hook strip (A) on the privacy flap with the loop strip sewn on to the bottom rear of the back cover (B).
5. Pull the opposite end of the privacy flap through the gap between the back and the wheelchair seat (C).
6. Secure the loop strip (D) on the opposite end of the privacy flap to the fastening strip on the wheelchair seat*.

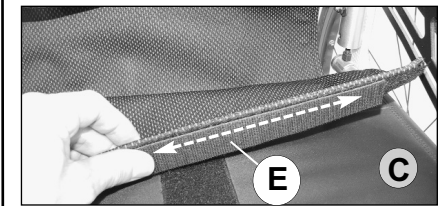
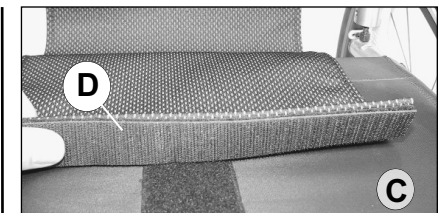
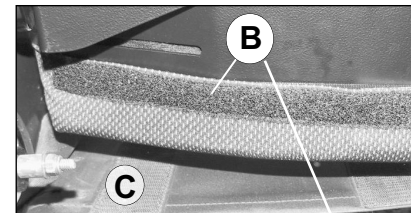

REAR VIEW

FRONT VIEW

***NOTE:** The fastening strip pre-installed on the wheelchair seat pan or sling upholstery may be either a hook strip or a loop strip. It may be necessary to install the double sided hook strip (E) onto the privacy flap to secure it to the seat.

10.0 Lumbar Support (Optional)

! PLEASE NOTE

The **Lumbar Support** is a pre-fabricated foam insert that provides lower back support for additional comfort. The position of the lumbar insert can be adjusted inside the Matrix Elite cover (see *instructions below*), or it may be removed if no lumbar support is desired.

Lumbar Support Adjustment:

Note: The lumbar support adjustment is illustrated using the Standard Elite Back

- To access the Lumbar Support, open the outer cover at the bottom rear of the back pan.

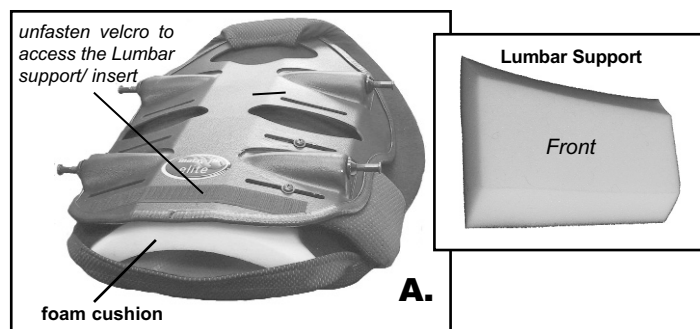

- The foam lumbar support/ insert is installed inside the Elite cover between the foam back cushion and the back pan (see image B. below)
- The lumbar support can be adjusted manually to any desired height/ position, or it can be removed completely if no lumbar support is required.

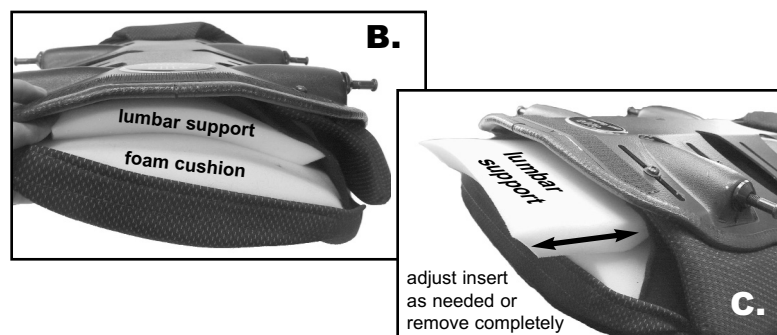

- Refasten the cover onto the back pan.

4.0 Before Installation - Important!

Back Size/ Weight Capacity

Matrix Elite HD Back	Back Widths	Back Heights	Weight Capacity
PBE-wwhh-HD	21",22",23",24"	16" , 20"	500 lbs
	53,56,58,61 cm	41"cm, 51 cm	227 kg

The Mounting Plates are shipped pre-assembled on the Cane Clamps in the *rearmost* mounting configuration. This maximizes the seat depth on the wheelchair seat (up to a maximum 2.5" (64mm) rearward offset - see **Figure 1** below).

By changing the orientation of the Mounting Plates on the Cane Clamps, the assembly can be reconfigured* to provide a more *forward* mounting position for the back if desired (up to a maximum 2.5" (64mm) forward offset - see **Figure 2**)

Note: Each mounting plates is also designed to provide 1.5" (38mm) of fore and aft adjustment relative to the cane clamp

***To reconfigure a mounting plate/cane clamp to the forwardmost orientation:**

- detach the Mounting Plate from the Cane Clamp (3 screws);
- Rotate the Cane Clamp 180° and re-fasten it to Mounting Plate;
- Install Cane Clamp as illustrated in **Figure 2**.

!WARNING! When establishing the mounting position for the Matrix Elite HD back, ensure the stability of the wheelchair is not compromised. Adjusting the forward and aft position of the backrest will alter the user's center of gravity within the wheelchair. A recessed back position can significantly reduce the rearward stability of the wheelchair. Similarly, a more forward back position will reduce the wheelchair's forward stability.

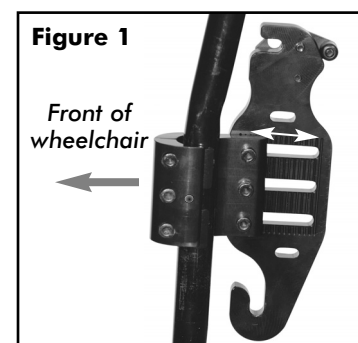

HD Mounting Plate in the rearmost back position (maximized seat depth).

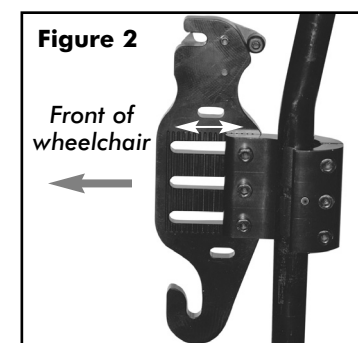

HD Mounting Plate in the forward most back position.

4.0 Before Installation - Important!

Accommodating Different Sized Back Canes:

- ◆ 1" (26mm) back cane - Cane clamps are installed without plastic inserts.
- ◆ 7/8" (22mm) back cane - Requires 7/8" (22mm) plastic inserts (provided)
- ◆ 3/4" (19mm) back cane - Requires 3/4" (19mm) plastic inserts (provided)

! PLEASE NOTE

On some wheelchairs, there may be an uneven seam along the back canes where a smaller diameter tube is inserted into a larger diameter tube. If the Cane Clamps must be mounted over this seam, the plastic inserts may be cut in half to allow the clamp to fasten securely onto the back canes (see Figure 4).

Figure 3

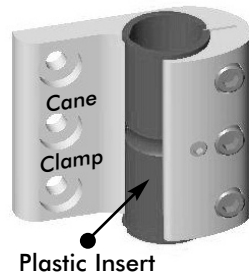
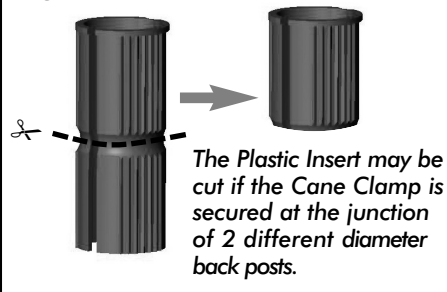

Figure 4



HELPFUL HINT

Spray a small amount of hairspray on the back canes and on the inside of the plastic inserts to create a secure 'no-slip' bond.

NOTE: For wheelchairs with short back canes, it may be necessary to install **Posture Back Cane Replacements** (PBCR's). The PBCR's are designed to replace existing push handles or cane extensions on standard 1" (26mm) back posts. The Cane Clamps can be mounted directly onto the replacement back canes in order to allow proper installation of the Matrix Elite HD back. Cane Replacements are available from Motion Concepts (**part#-TRX2810**).

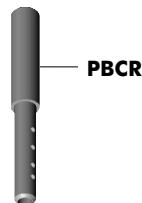

PBCR

9.0 One-Hand Cord Release Mechanism (Optional)

Installation Instructions:

Note: The cord release mechanism is illustrated using the Standard Elite Back

1. Thread the **Nylon Cord** through the holes in the latch mechanism at the top of the left and right mounting plates (see image A. below.)



2. Install the spring loaded **Cord-Lock** mechanism onto the nylon cord (see image B. below). Press the button to open the lock mechanism and slide the two open ends of the cord through the opening.

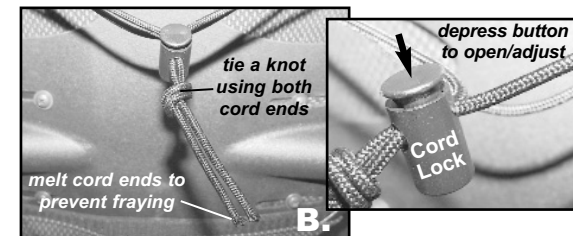

3. With the back properly installed on the wheelchair, adjust the cord length so that it hangs at approximately a **45° angle** along the back pan (this will allow the release mechanism to operate more effectively). If necessary, **cut/remove excess cord** to eliminate any risk of entanglement. Once adjusted, combine the loose cord ends into a single knot to prevent the cord-lock from slipping. (**Note:** if the cord length was modified, carefully melt the ends of the cord to prevent fraying)

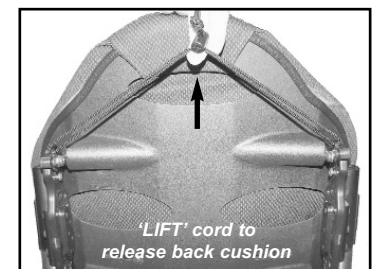

NOTE: Cord is shown installed on a Standard Elite Back

8.0 Lateral Supports (Optional)

Instructions for Installing Lateral Supports:

- 1 Pull up the bottom of the cover (release velcro fasteners) to expose the mounting slots/channels in the back pan.
- 2 Determine the desired mounting height/orientation for the lateral pads (*upper or lower mounting slot position*).
- 3 If applicable, carefully bend the lateral support(s) to the desired contour (*prior to installation*).
- 4 Loosely install the lateral supports onto the back pan using the hardware provided.
Note: hardware can be installed in either orientation on the back pan (with backing plates located on the inside or outside of the back pan).
- 5 Adjust laterals to the desired position via the mounting slots on the backpan and via the slots in the lateral support bracket. Secure each lateral support into place.
- 6 Re-attach the back cover via the velcro fasteners.

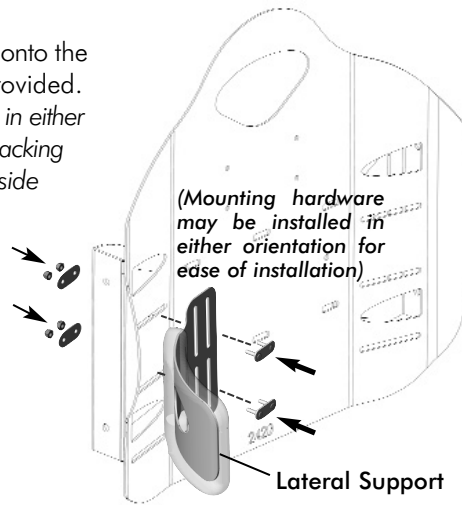

Lateral Support Mounting Slots

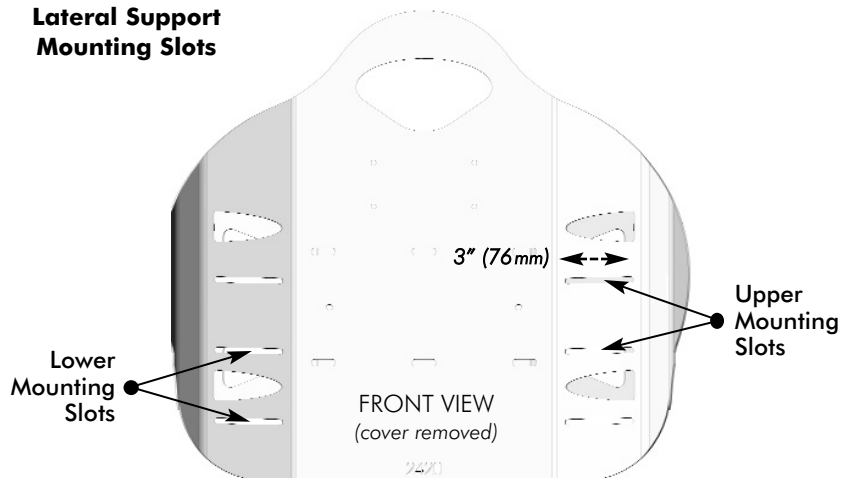

5.0 Matrix Elite HD Installation

⚠ WARNING! The installation hardware provided is high strength and tested for durability. **DO NOT** substitute hardware. Use only the hardware supplied.

- 1 Remove existing wheelchair back upholstery (if applicable).
- 2 Establish the desired Mounting Plate set-up/configuration for the user (per **Section 3.0**).
- 3 Loosen Cane Clamp screws (x3) and loosely install the cane clamp (with mounting bracket) onto each back cane. (*Install plastic inserts if required*).
- 4 Starting on one side, position the Cane Clamp at the desired height on the back canet and tighten the clamp screws enough to hold it in place. (*Clamps and set screws will be fully tightened after the back is installed and all final adjustments have been made.*)
- 5 From a fixed point on the wheelchair (e.g. seat frame/rigidizer bar) measure the exact height of the *installed* Cane Clamp assembly, and install the second Cane Clamp at the same height on the opposite back cane - see **Figure 5** below. Ensure the Cane Clamps/Mounting Plates are mounted parallel with each other.

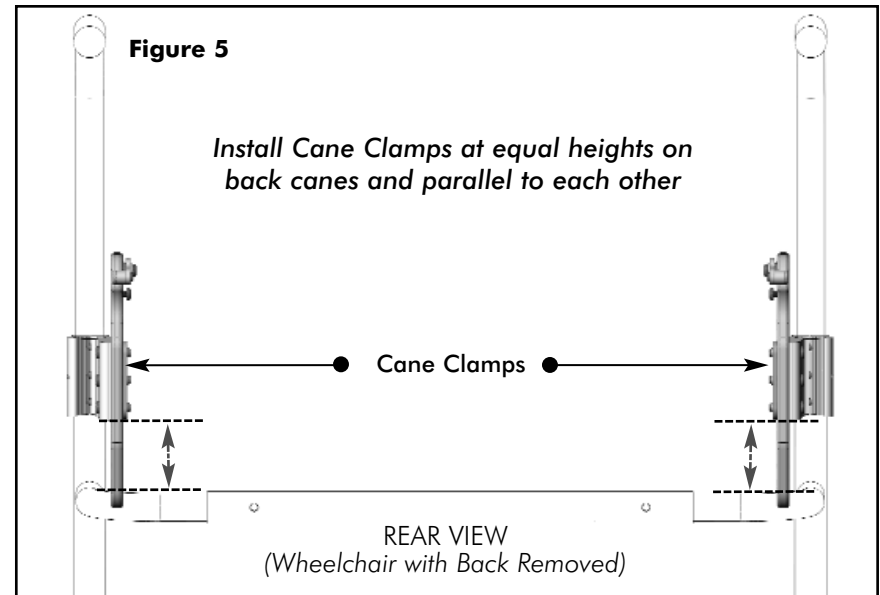

5.0 Matrix Elite HD Installation

! PLEASE NOTE

Additional upper and lower adjustment slots are provided on the Mounting Plate to allow alternate mounting heights if obstacles are encountered. Using these Alternate Mounting Slots will increase or decrease the back height by 7/8" (22mm). (note: these alternate slots will limit the range of available depth and/or recline angle adjustment).

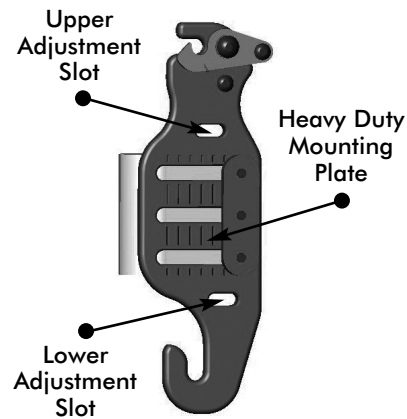

- 6 To install the Matrix Elite HD back onto the mounting plates:
- Step 1:** Slide the lower mounting pins into the hooked slots at the bottom of each mounting plate (1). (see **Figure 6**).
- Step 2:** With the lower pins in place, lock/snap the upper mounting pins into the latch mechanism at the top of the mounting plates (2).

! WARNING! Ensure both latch mechanisms are fully engaged around the upper mounting pins following installation.

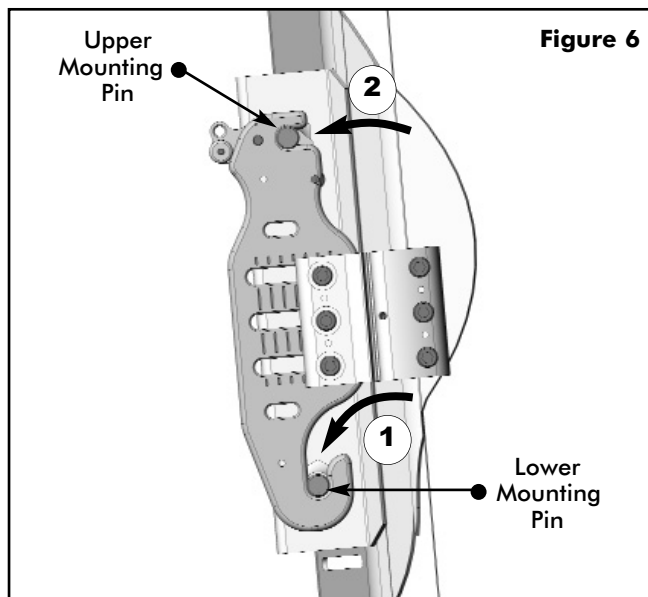

7.0 Removing the Cover/Care Instructions

Carefully remove the cover by releasing the velcro hook and loop fasteners along the top & bottom edge and inside of the back shell.

General Care and Cleaning: The cover may be easily wiped down with a damp cloth when necessary. Before laundering the inner foam cushion must first be removed from the outer cover. For specific laundering directions, please follow the washing instructions provided with the cover.

8.0 Lateral Supports (Optional)

Lateral Pads are available on the Matrix PB Elite Heavy Duty backs as an option for additional lateral support. Lateral Pads are offered in small, large and offset styles (see **Figure 8** below). Mounting slots in the back shell and the lateral support brackets allow for adjustment both vertically and laterally. Upper and lower mounting slots are provided on the back pan for an even greater range of adjustment. (Refer to p.12 for detailed installation instructions).

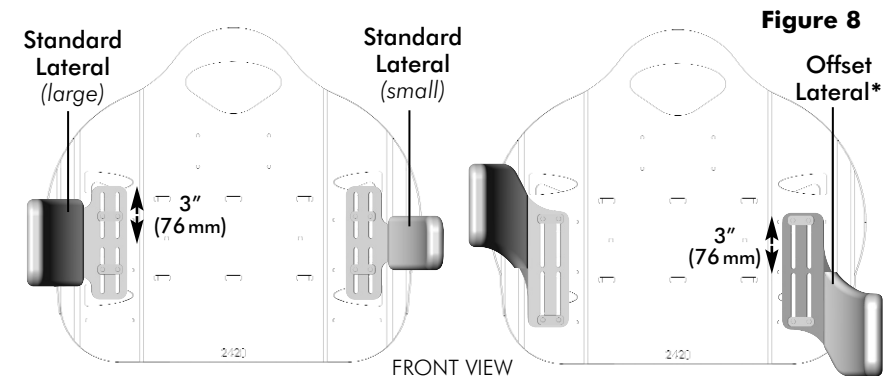

*note: offset laterals may be mounted to the back pan in either orientation (as shown) to provide extended support

! PLEASE NOTE

Lateral Supports may be further customized by carefully bending** the lateral to a more desirable contour/ position for the client.
****Important!** To prevent damage to brackets and hardware, always remove the lateral supports from the back pan prior to bending.

6.0 Disengaging the Matrix Elite HD

To Disengage the Back from the Wheelchair:

Step 1: Simultaneously lift the release levers (left & right) to unlock the latch mechanism (1) and release the upper pins from the mounting plates (2). Refer to **Figure 7** below.

(note: for backs equipped with the one-hand cord release mechanism, lift cord upward to unlock/open the release levers -see **Section 9.0: One-Hand Cord Release Mechanism**).

Step 2: Lift entire backrest up and forward to disengage the lower pins from the lower slots in the mounting plates (3).

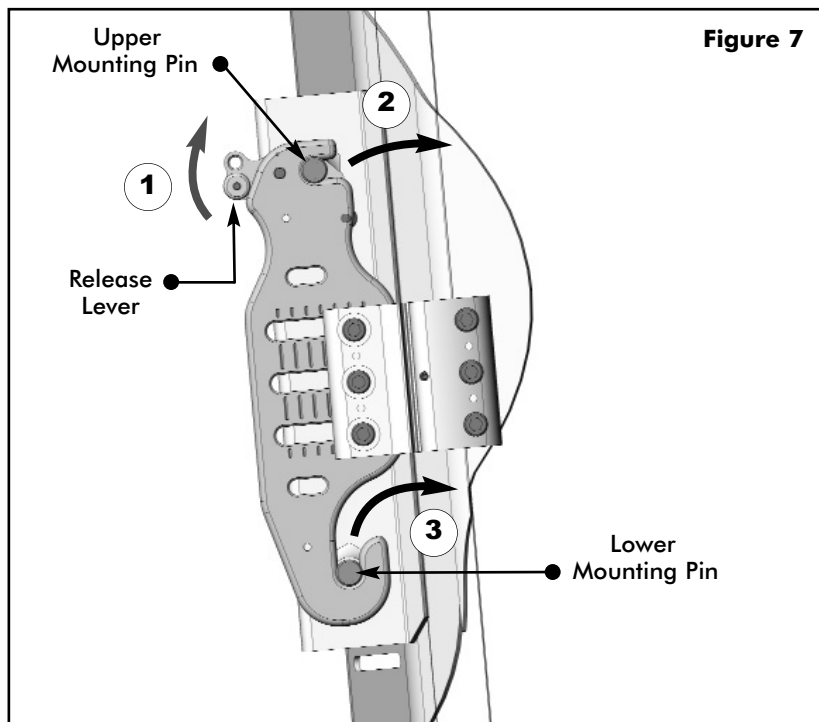

5.0 Matrix Elite HD Installation

7 Before proceeding with the final set-up, the mounting pins will require adjustment to ensure the backrest is properly fitted/secured to the wheelchair.

! PLEASE NOTE

Matrix Elite HD backs are available in four **widths**: 21" (53cm), 22" (56cm), 23" (58cm) and 24" (63cm); and two standard **heights**: 16" (41cm) and 20" (51cm). Due to variances that exist between different wheelchair manufacturers, the depth of the mounting pins may require some adjustment to properly fit the Matrix Elite HD back onto the wheelchair back canes (see Step 8). Two sets of depth adjustable pins are supplied with every back: **Standard Pins (x4)** and **Long Pins (x4)***. Our standard pins come factory installed and are suitable for most typical wheelchair configurations. Long pins are designed to allow installation onto back canes that are up to 1" (25mm) wider than the width of the actual backrest.

Example: 22" (56 cm) Matrix Elite HD fits:

22" (56 cm) wheelchair seat frame (back cane width) = **Standard Pins**

23" (58 cm) wheelchair seat frame (back cane width) = **Long Pins**

*NOTE: when exchanging mounting pins, the **Pem-Nut Backing Plates** (not shown) must be re-aligned with the new mounting pins in order to complete the installation.

Matrix Elite HD (rear view)

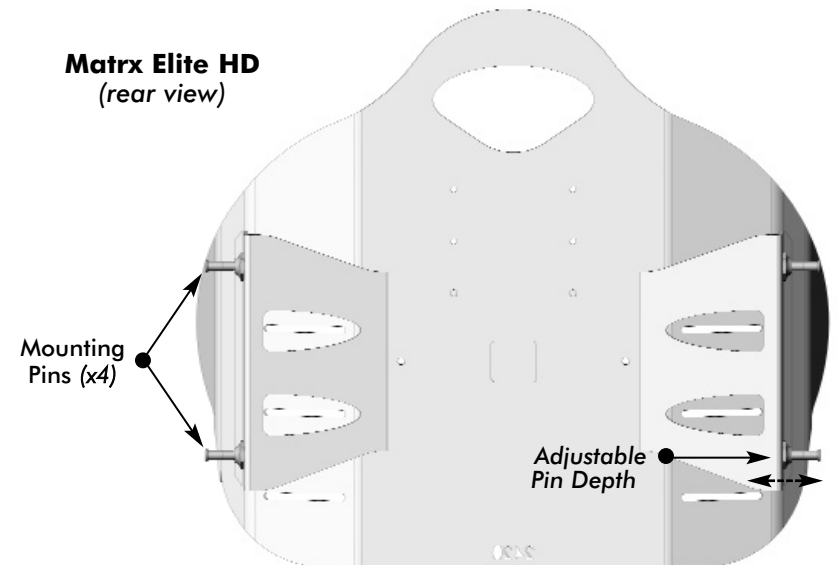

⚠ WARNING! Extended Mounting Pin (EMP) Kits: Extended mounting pins allow a back to be installed on back canes up to 2" wider than the back width. EMP kits are **only** for use with our standard sized Matrix Elite backs (up to max. 300lb (136kg) weight capacity). **NEVER** use EMP's with the Matrix Elite HD back.

5.0 Matrix Elite HD Installation

- 8 To adjust the mounting pins:
- With the back secured in place on the wheelchair, determine the amount of adjustment required for each mounting pin (see below).
 - Remove the backrest from the wheelchair and use the wrench provided to loosen each flange nut. (If necessary, replace the standard mounting pins with long mounting pins).
 - Adjust the mounting pin depth (clockwise to shorten/counter-clockwise to lengthen) so that a minimum gap of 1/8" (3mm) exists between the top of the pin and the mounting plate. Re-tighten each flange nut to secure the pins in place. (ensure pins do not rotate when tightening the flange nuts- **NEVER** use loctite on mounting pin hardware).

⚠ WARNING! Ensure all flange nuts are **fully tightened**; Failure to do so may cause damage/cracking in the back pan

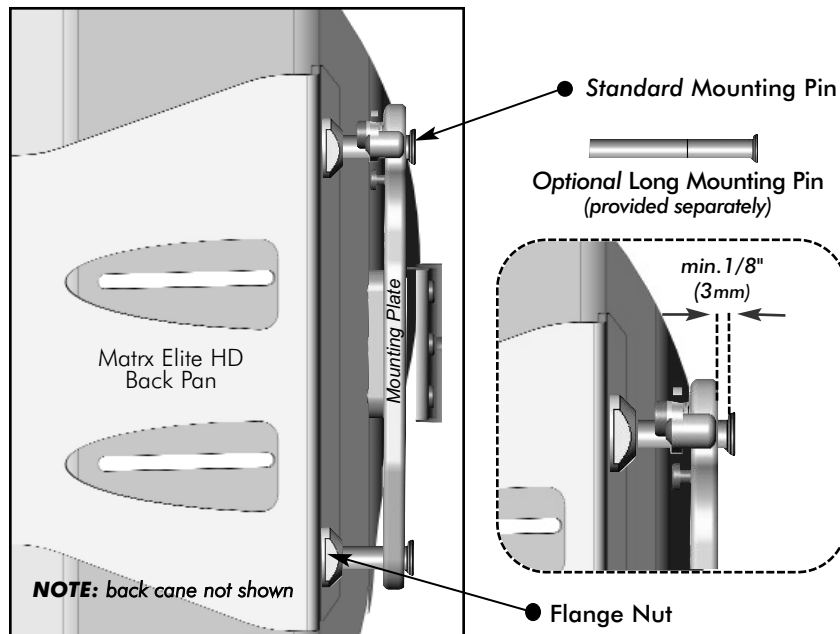

⚠ WARNING! Improper pin set-up may cause damage to the back pan and/or the mounting plates. Ensure sufficient spacing is provided between the mounting plates and the mounting pins (a min. gap of 1/8" (3mm) is recommended).

5.0 Matrix Elite HD Installation

- Verify that the overall fit and alignment of the back is correct (make adjustments as needed).
- Fully secure the Cane Clamp Screws onto both back posts, and tighten the set screws to ensure the mounting plates do not slip or rotate.
- To best determine the optimal depth & recline settings for the back, the user should be seated in the wheelchair. While seated, loosen the depth/recline screws on the mounting plates and adjust the back to the desired depth and recline angle. Re-tighten all screws to lock the back in position.

Ensure that the depth/recline adjustment for the back is made **symmetrically*** on the left & right mounting plates.

! PLEASE NOTE

The vertical score lines on the mounting plates are designed as a point of reference to assist with symmetrical mounting (see image below). Since the back can be mounted in a rotated (reclined) position if desired, it will not always be mounted parallel with these vertical lines.

*Use score lines to make symmetrical adjustments on the left and right mounting plates.

